

Government of West Bengal
Irrigation & Waterways Directorate



Office of the Executive Engineer
Howrah Irrigation Division
Onkarmal Jetia Road,
P.O. - Botanical Garden,
P.S-Shibpur, Dist- Howrah,
Pin- 711 103, Phone no. 033-26881521,
e-Mail id: dpiu.howrah21@gmail.com

Memo no. 1712

Dated. 16.11.21

**1st CORRIGENDUM TO RFQ No: WBMIFMP/DPIU-HOWRAH/NCB-01/21-22/
REFURBISHMENT-PENRO, issued on 02.11.2021**

Contract title: "Refurbishment of Office Building at Penro Irrigation Campus in Block Udaynarayanpur, Howrah District, under Howrah Irrigation Division, I&W Directorate Govt. of West Bengal"

The construction drawings along with location map has been uploaded in respect of *RFQ No:* WBMIFMP/DPIU-HOWRAH/NCB-01/21-22/ REFURBISHMENT-PENRO

Tender ID: 2021_IWD_349771_1

ALL OTHER TERMS AND CONDITIONS WILL REMAIN UNCHANGED.

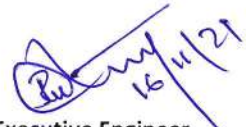
Executive Engineer
Howrah Irrigation Division

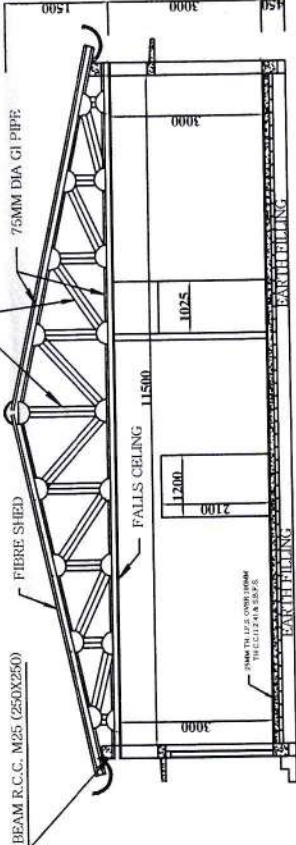

16/11/21



SECTION AT- XX

DOOR WINDOW SCHEDULE

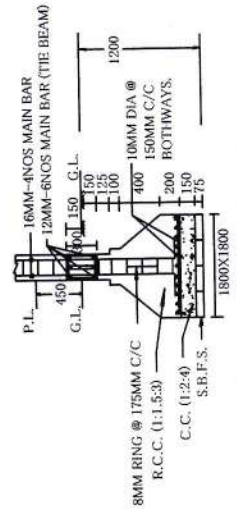
MARK	SIZE IN ML
D	1.20 x 2.10
D1	0.80 x 2.10
W	1.80 x 1.30
G	0.90 x 2.10
Sk1	0.75 x 0.50



SECTION OF COLUMN

NOTE :-

1. ALL DIMENSIONS ARE IN MM EXCEPT WHERE MENTIONED.
2. COLUMN SIZE (250X250), FLOOR BEAM SIZE (250X250).
3. FOOTING SIZE (1800X1800), TIE BEAM SIZE (250X300).

[Handwritten Signature]

Executive Engineer
Hourah Irrigation Division

[Handwritten Signature]
24/08/2024

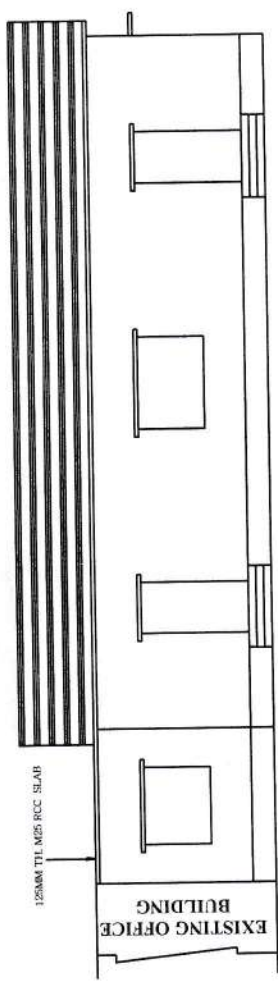

FRONT ELEVATION

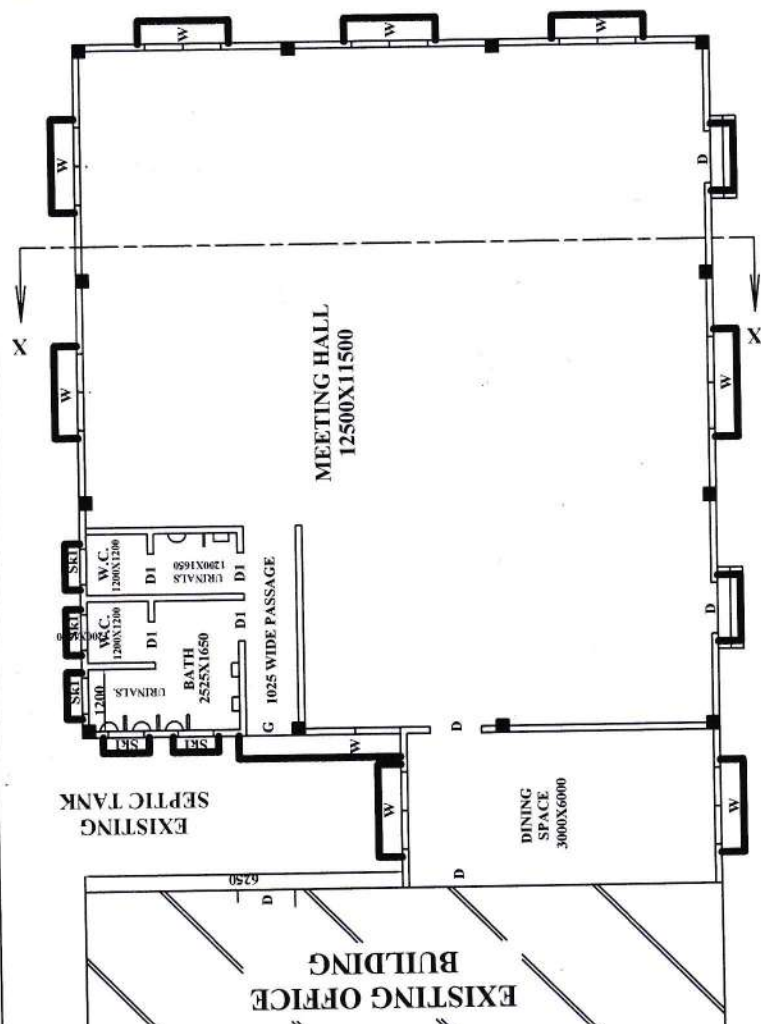

PLAN OF MEETING HALL WITHIN
POSHPUR OFFICE COMPOUND

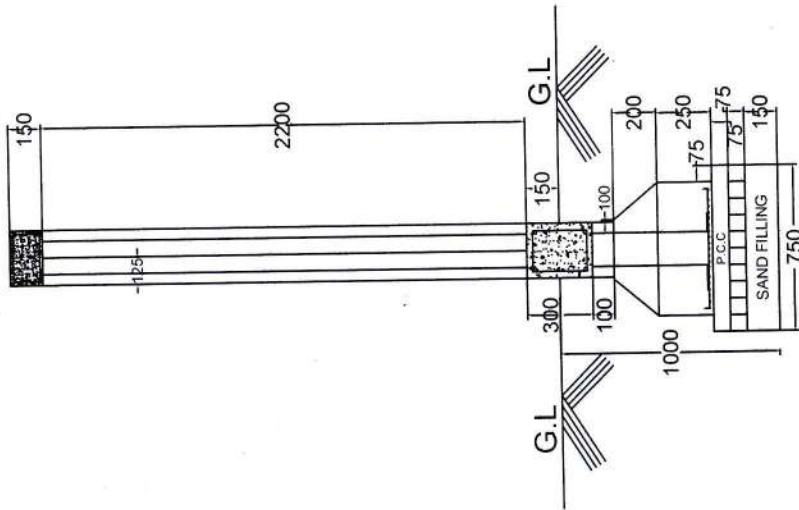

CROSS SECTION OF BOUNDARY WALL AT A-A

Signature
24/08/2024

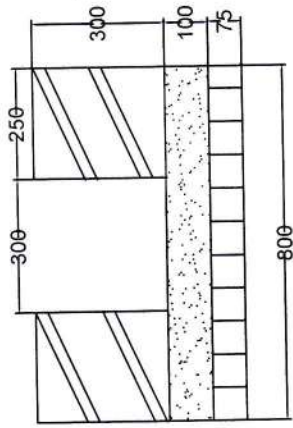

CROSS SECTION OF CROSS & SIDE DRAIN

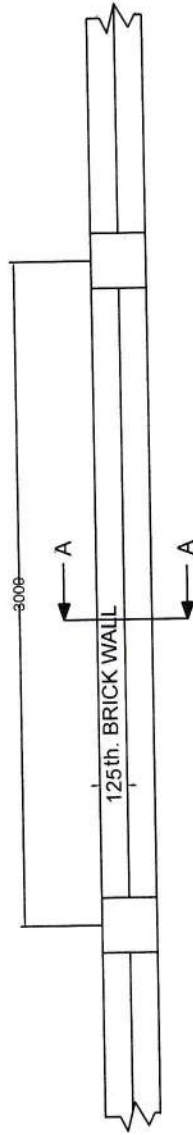

LONG SECTION OF BOUNDARY WALL

ALL DIMENTION ARE IN MM.

Signature
Executive Engineer
Howrah Irrigation Division

INDEX MAP OF HOWRAH IRRIGATION DIVISION

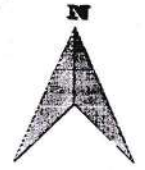

PROPOSED WORKING ZONE

Proposed Scheme

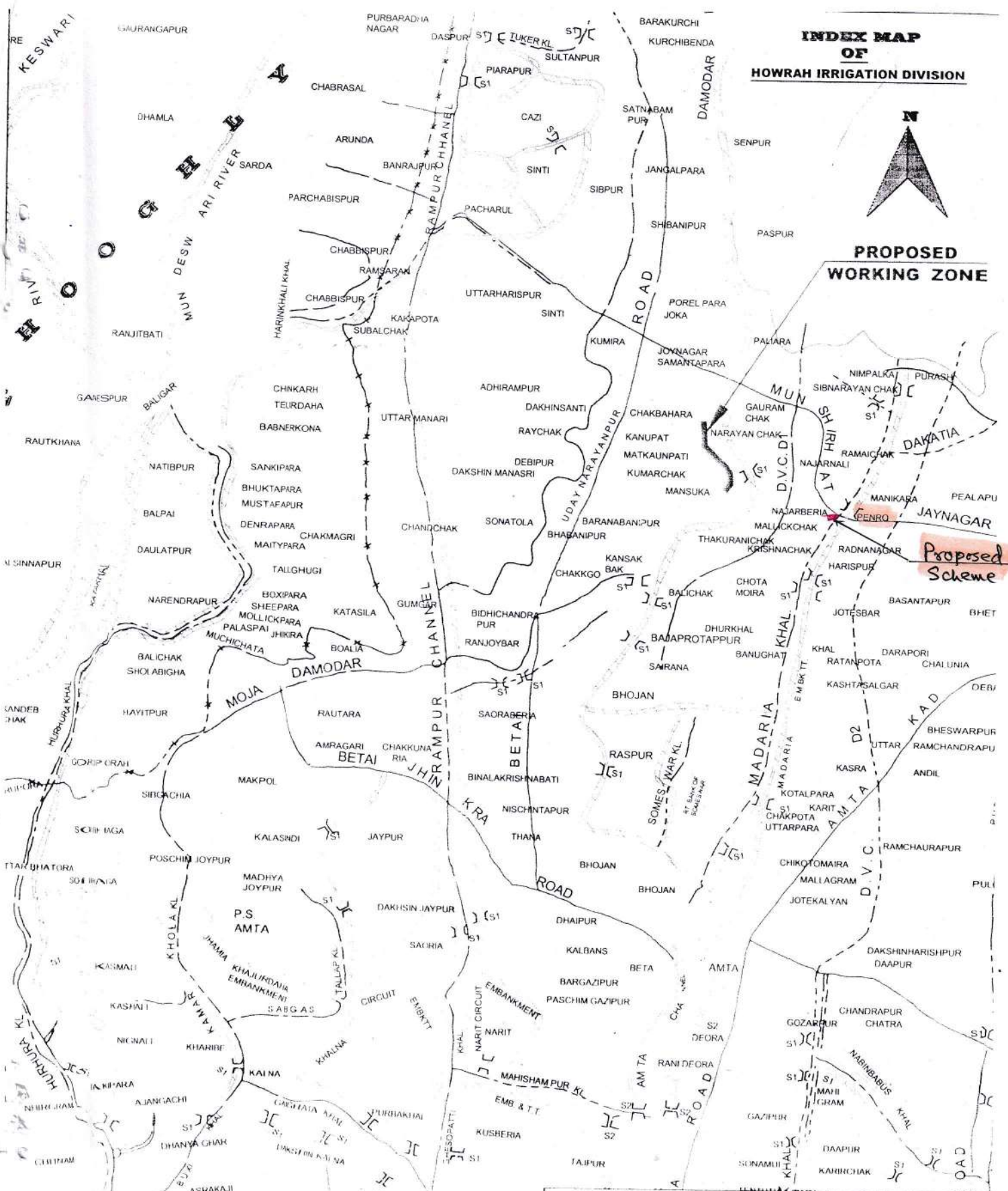

LEGEND:-

- SLUICE
- CANAL & RIVER
- EMBANKMENT
- ROAD

GOVT. OF WEST BENGAL
IRRIGATION AND WATERWAYS DIRECTORATE
NAME OF WORK
 "Refurbishment of Office Building at Penro Irrigation Campus in Block Udaynarayanpur, Howrah District, under Howrah Irrigation Division, I&W Directorate Govt. of West Bengal"

(Handwritten signature and date)